

"MEMORY" Accessori / Accessories

Istruzioni di montaggio / Instructions for installation

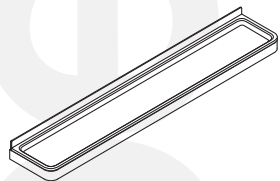

MEM856
700x126x50

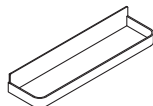

MEM857
360x90x50

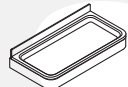

MEM852
240x126x50

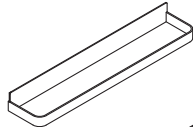

MEM858
480x90x50



MEM851
120x126x50

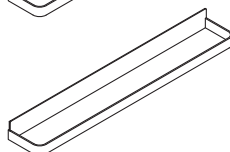

MEM859
600x90x50



MEM854
120x126x50



MEM853
120x126x129



MEM855
120x126x129

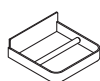

MEM860
146x142x50

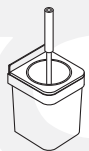

MEM861
288x142x50

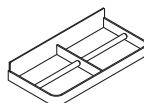

Tutte le misure sono in millimetri.
All measurements are in mm.

STRUMENTI / TOOLS



FERRAMENTA / FASTENERS

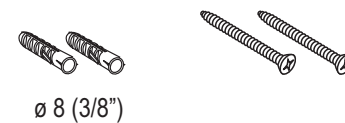

MANUTENZIONE / MAINTENANCE:

Per la normale pulizia si consiglia di utilizzare detersivi di uso comune. Si sconsiglia l'utilizzo di detersivi abrasivi, acidi e anticalcare.

For normal cleaning use common detergents. Do not use either abrasive detergents or solvents, acids and anti limestone.

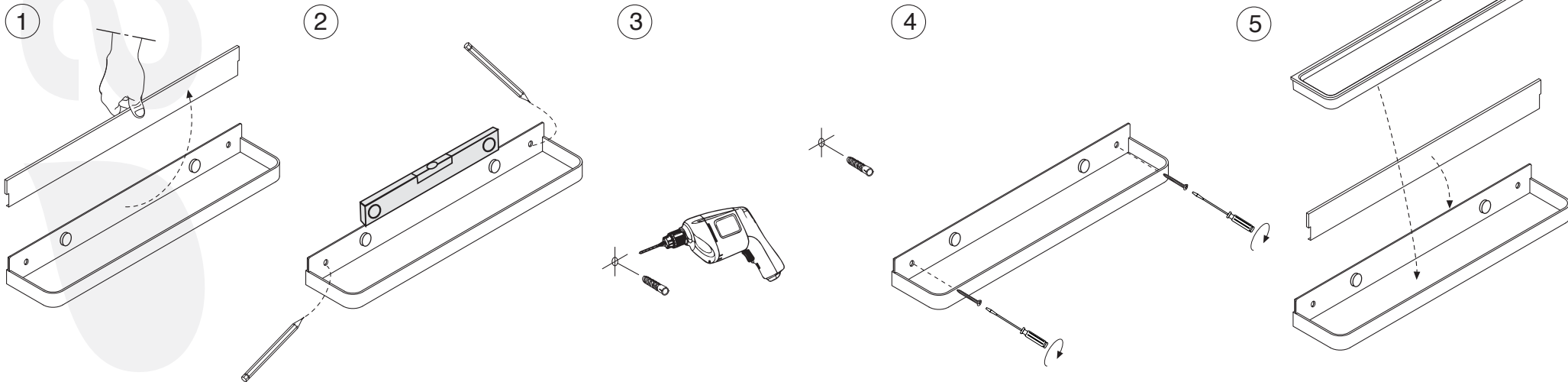

agape srl Via A. Pientino 6 - 46037 GOVERNOLO tel. 0376250311 Cod. dis 11031 Febbraio 2011