

"AKIT680B" Guide per incassi SEN / Rails for recessed SEN parts

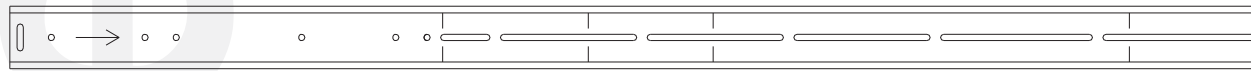

.FER0680A

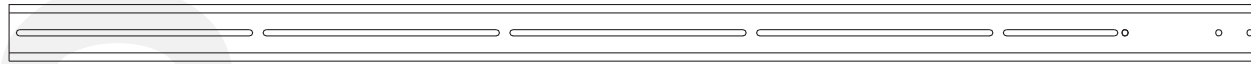

.FER0680B

FERRAMENTA/ FASTENERS

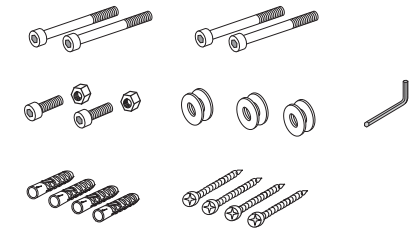

STRUMENTI/ TOOLS

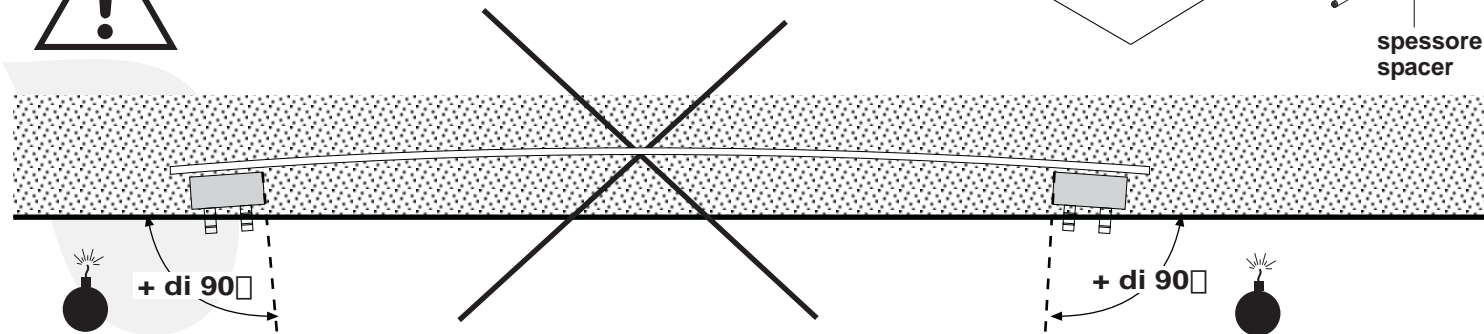
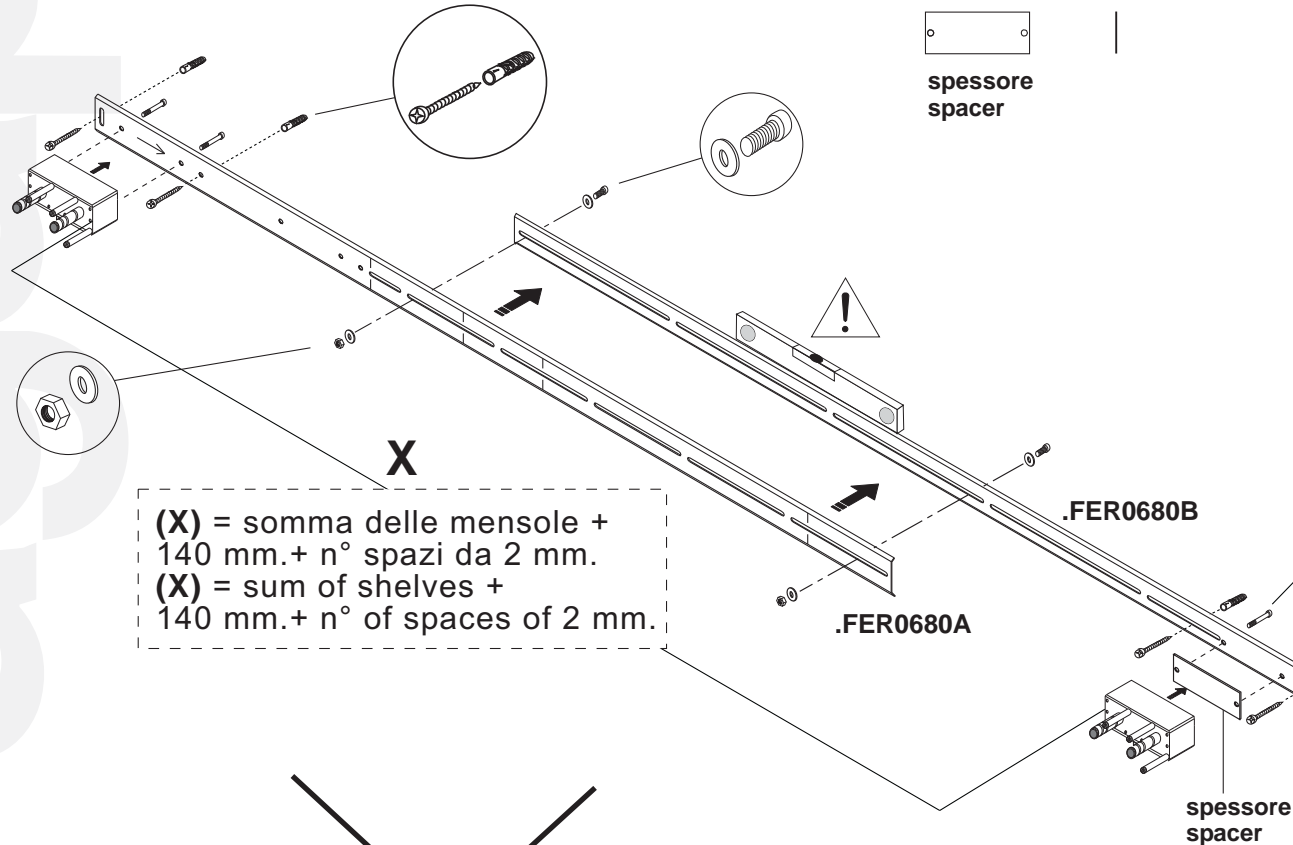
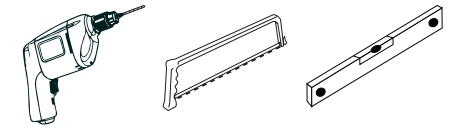

"AKIT680B" Guide per incassi SEN / Rails for recessed SEN parts

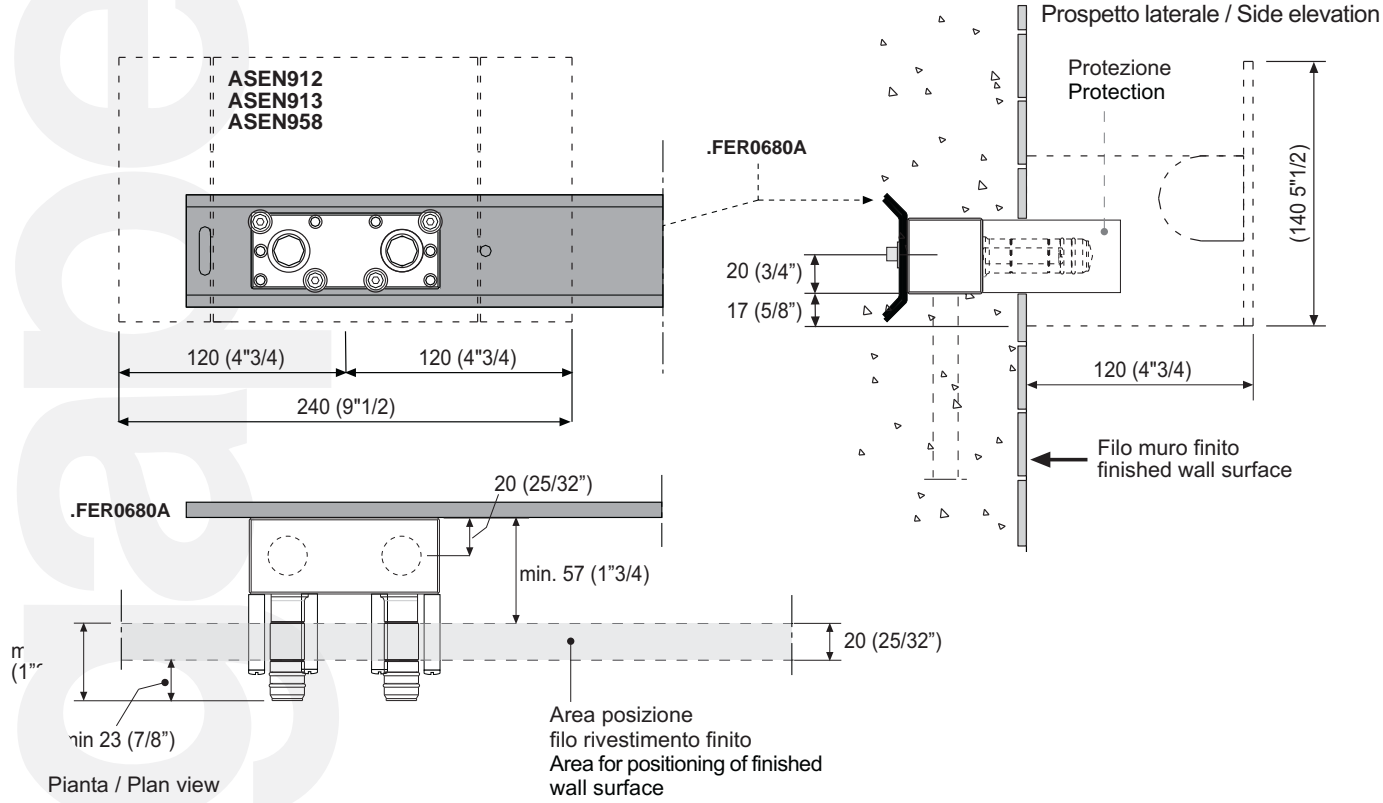

Mensole utilizzabili nelle composizioni Shelves that can be used in the composition

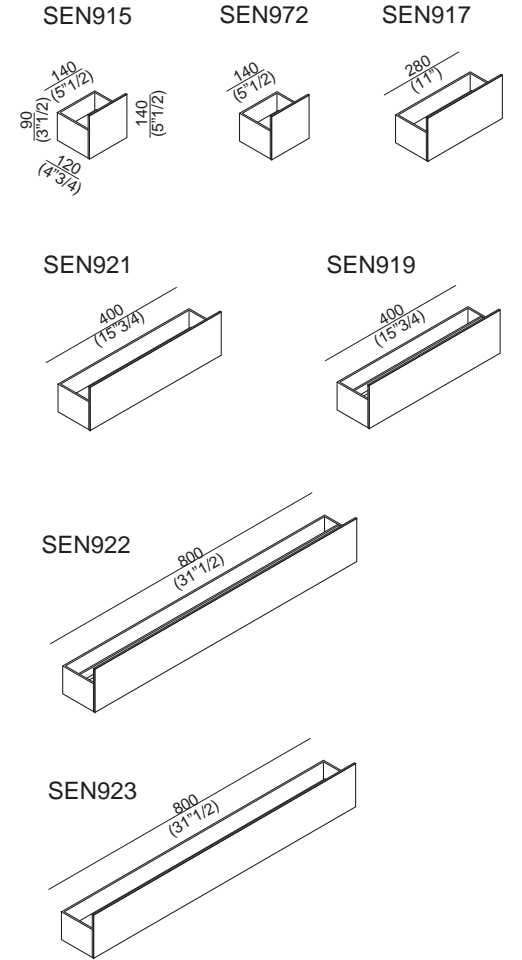

Esempio di composizione / Example for composition

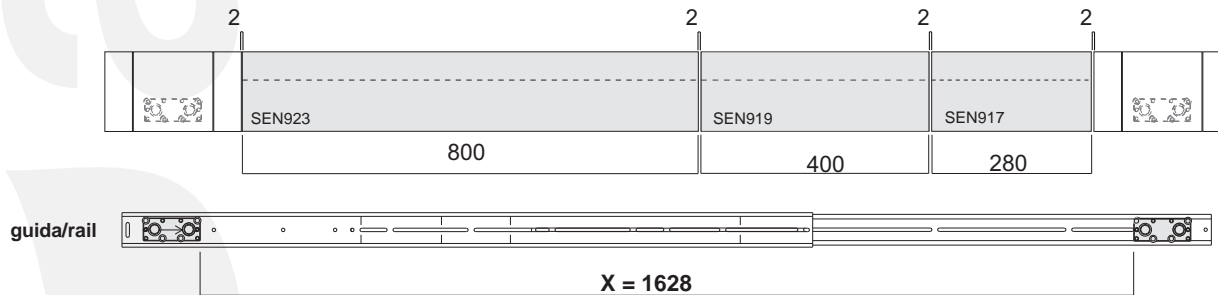

$$X = 800 + 400 + 280 + 140 + 8 \text{ (4 spazi/spaces)} = 1628$$